

# HERITAGE<sup>®</sup>

## BATHROOMS

### Installation Instructions & User Guide

Please leave these instructions with the end user

Product Code: TTRCC00 (D2)

#### Specifications

##### Dynamic Water Pressure

Min: 0.2 bar      Max: 5.0 bar

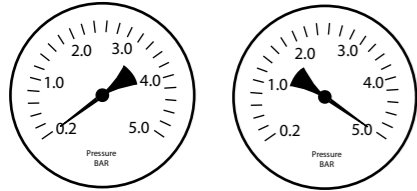

Maximum Static Pressure: 10.0 bar

##### Inlet Water Temperature

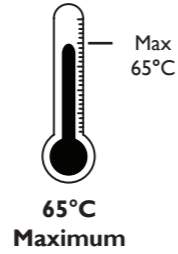

##### Inlet Connections

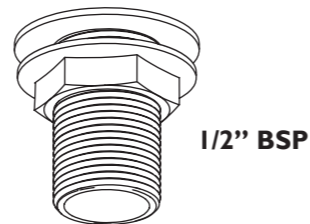

#### Tools You'll Need

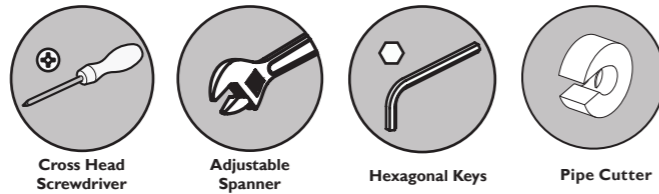

#### Prior to Installation

All products manufactured and supplied by Heritage are safe to use provided that they are installed, operated and receive regular maintenance in accordance with these instructions.

This product needs to be installed in accordance with, and meet the requirements of the Water Supply (Water Fittings) Regulations 1999 and current by-laws. For full Installation Requirements & Notes (IRN) please visit [wras.co.uk/directory](http://wras.co.uk/directory).

Isolation valves must be fitted to the inlet water supplies to ensure ease of future maintenance.

Before installing this product the water supply must be thoroughly flushed in order to remove any swarf, solder etc. Full access must be made available for future maintenance/servicing purposes.

This product must not be modified in any way as this will invalidate the guarantee.

If in doubt, contact a registered plumber, your Local Water Authority or the Secretary of the Institute of Plumbing, address as follows:-

The Institute of Plumbing,  
64 Station Lane,  
Hornchurch,  
Essex,  
RM12 6NB, Tel: 01708 472791

#### Pack Contents

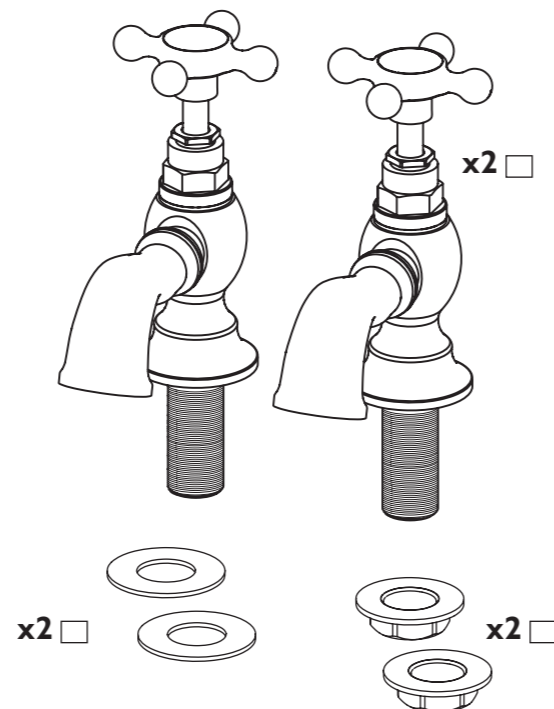

#### Installation

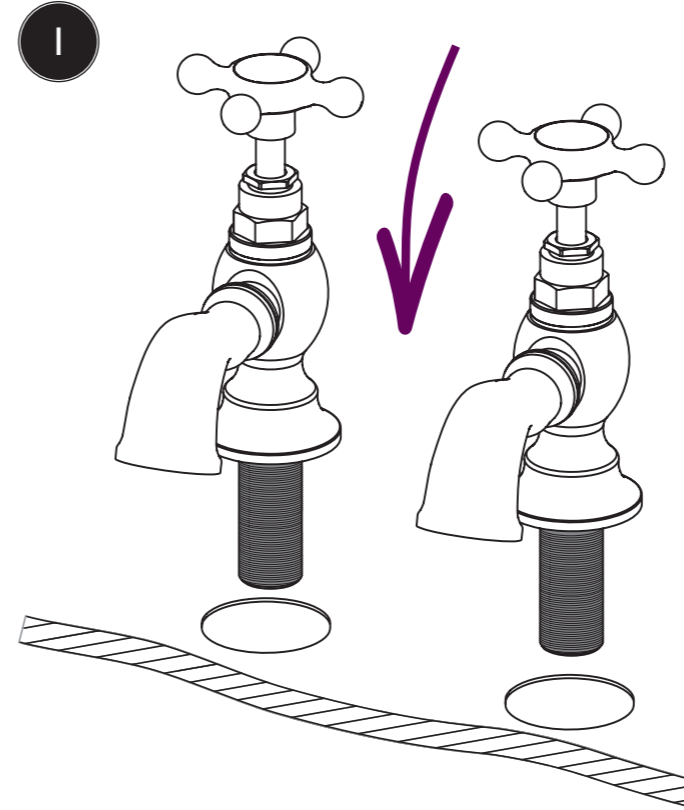

Fit the taps to the basin.

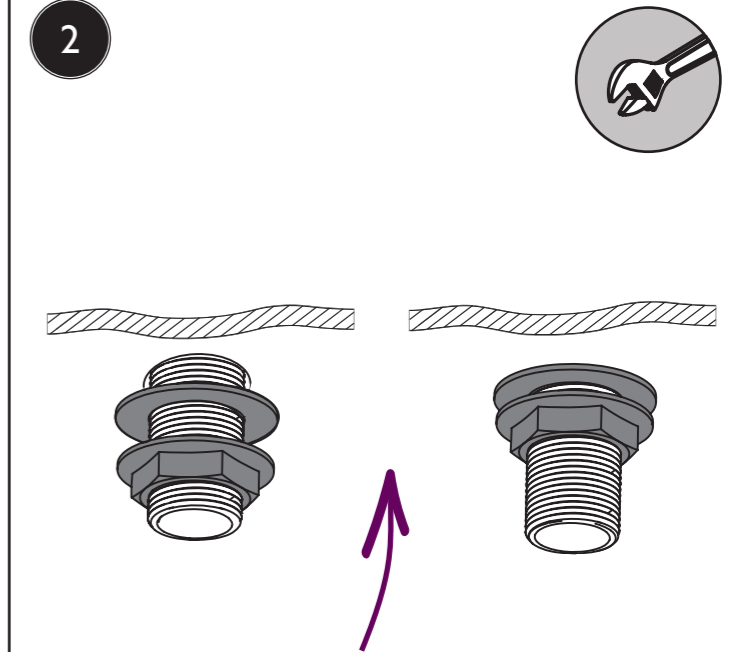

Secure the taps to the basin by using the washer and metal backnut below the basin.

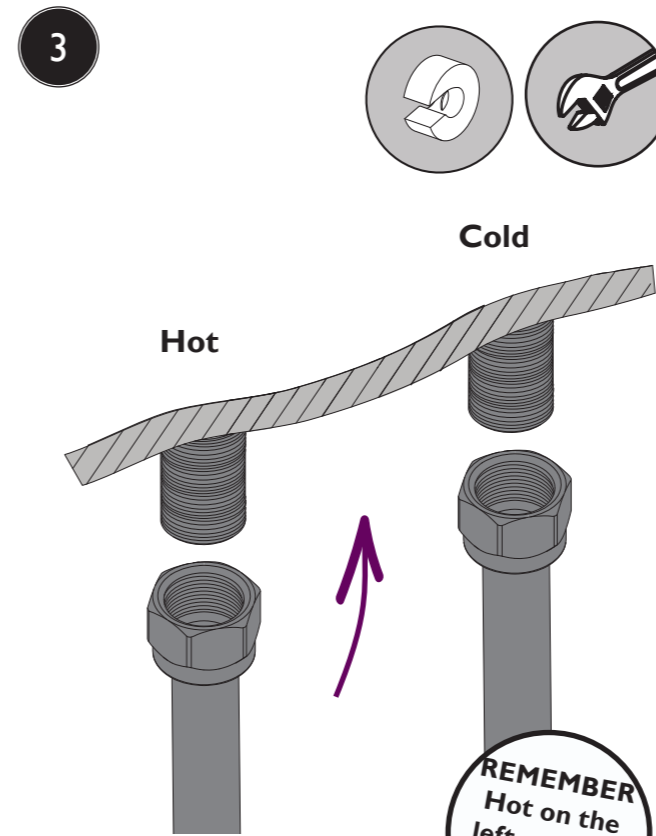

Connect the hot and cold water supplies to the threaded tails.

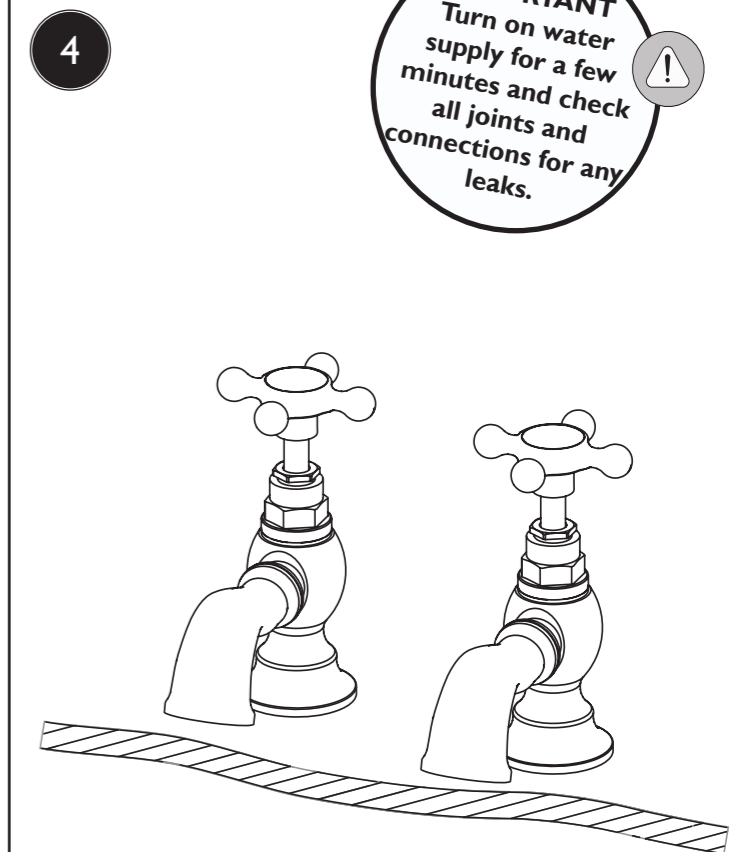

Turn on water supply.

## Operation

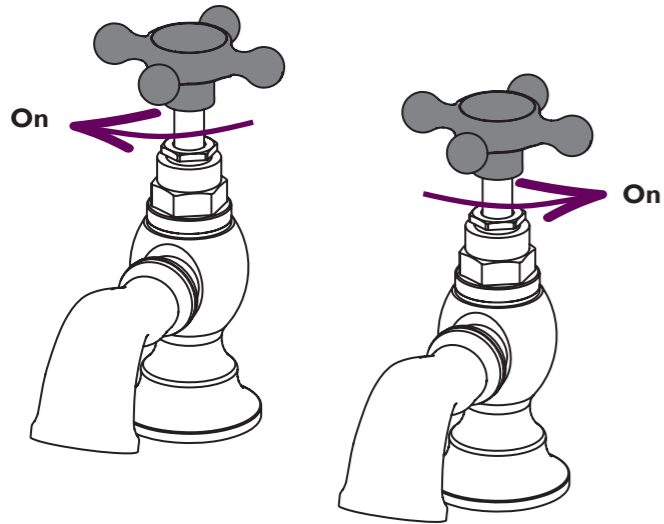

## General Cleaning

Heritage products are made from premium materials, with hand polishing, PVD, EPD and electroplated finishes.

Your product should be regularly cleaned with warm water, a mild pH-neutral liquid soap, and polished with a soft cloth. Any residues from soap, toiletries etc. should be rinsed off straight after use.

Household bleaches and cleaners contain harsh chemicals and may damage the surface finish. Avoid using abrasive cloths, scouring pads, scrub sponges, steel wool or anything similar.

Some surfaces such as nickel and pewter may be affected by the dye found in some cloths, so it is also important to avoid leaving cloths on surfaces.

## Troubleshooting

Symptom	Cause	Remedy
<b>No flow or low flow rate</b>	Partially closed isolation valve.	Open isolation valve.
	Instantaneous water heater cycles on and off as flow rate or pressure is too low.	Increase water flow rate or pressure through system.
	Head of water is below the minimum distance required.	Refer to specification for minimum distance required.
	Hot or cold water being drawn off elsewhere causing pressure changes or instantaneous boiler temperature changes.	Do not use other water outlets when using the taps.
	Airlock or partial blockage in the supply pipework.	Flush through pipework to ensure removal of debris and any airlocks.
<b>Water dripping from taps</b>	This is normal for a short time after using the taps.	This is caused by residual water tension, the build up of water in the tap body.
	If water continues to drip, possibly due to the ceramic disc valves	Remove valves and clean, refer to 'Maintenance' section before starting any maintenance.
<b>Taps do not turn on</b>	Closed isolation valve.	Open isolation valve.
	Mains water supply turned off.	Turn on mains water supply.

## Maintenance - Replacing Valves

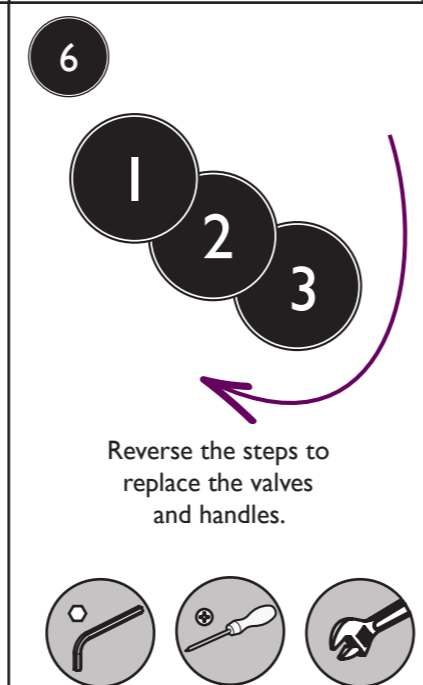
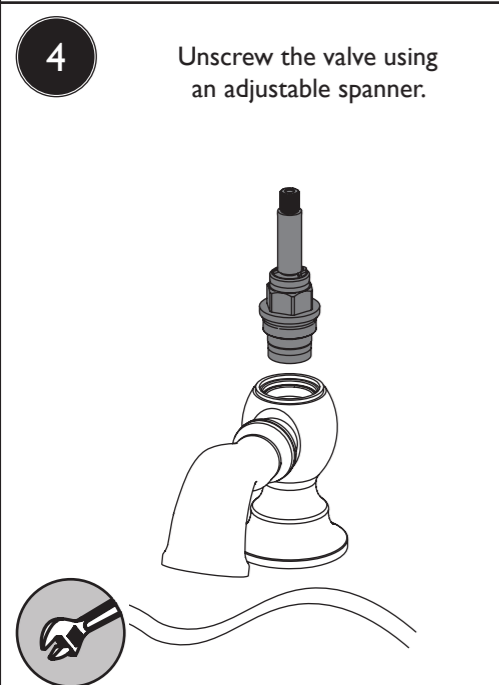
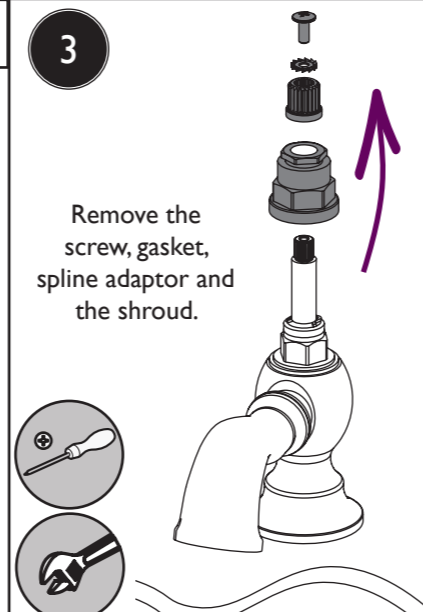
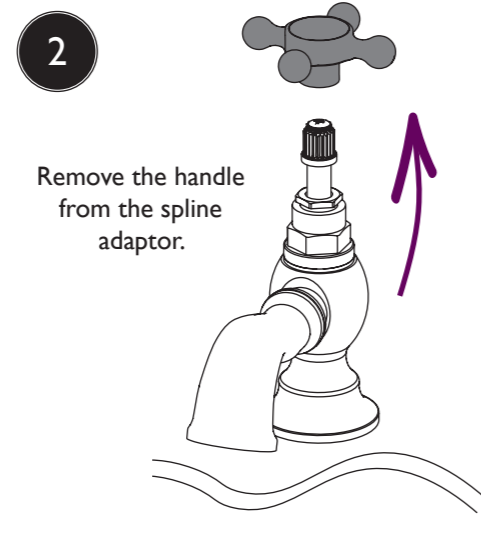
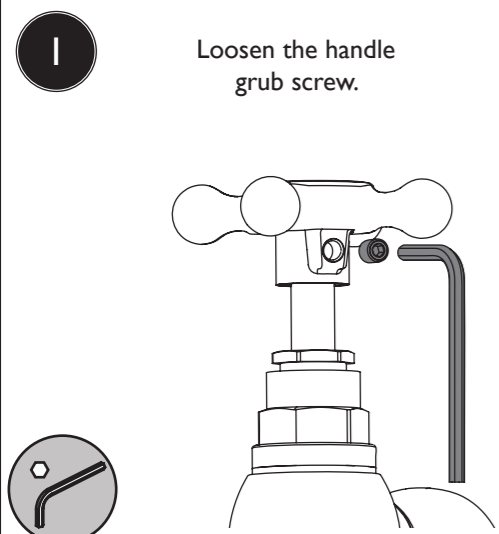

## Notes

Please use this space for any notes you or your installer may have regarding the installation/plumbing of this product.

## Contact Us

### Bristan Group Ltd.

**UK:** Heritage Bathrooms, B78 ISG.

**EU:** Masco Europe S.à.r.l.  
14 Rue Strachen  
6933 Mensdorf  
Luxembourg

**Customer Service:** +44330 026 8503

**Web:** [www.heritagebathrooms.com](http://www.heritagebathrooms.com)

**Email:** [enquire@heritagebathrooms.com](mailto:enquire@heritagebathrooms.com)

**A Masco Company**

## Our Guarantee

The confidence we have in the quality of our products and services enables us to offer a free peace-of-mind product guarantee from 2 years up to a lifetime guarantee against any manufacturing faults, with proof of purchase. In addition, our attentive customer service team are available to help solve any problems which may arise quickly and effectively so you can enjoy your bathroom.

To see the specific guarantee for this product, scan the QR Code or visit the following URL:

<https://www.heritagebathrooms.com/service-centre/guarantee>

