



## Specification

Finish/Colour:	Gold Plated
Main Construction Material:	Brass
No of Controls:	2
Shower Type:	Exposed Concentric
Shower Head Type:	N/A
Shower Kit:	Valve Only
Valve/Cartridge Type:	Concentric Cartridge
Maximum Hot Water Supply Temperature °C:	65
Plumbing System Suitability:	Suitable for all plumbing systems
Minimum Dynamic Pressure (bar):	0.1
Maximum Dynamic Pressure (bar):	5
Maximum Static Pressure (bar):	10
Connection Inlet:	15mm Compression
Connection Outlet:	G 1/2"
Isolation Valve Included:	No
Check Valve Included:	Yes

## Features:

- Optimised for UK market, designed to work at pressure range of 0.1 - 5.0bar
- Thermostatic temperature control and automatic stop prevent surges of hot or cold water
- Performance Flow to provide a drenching experience
- Adjustable inlet centres, allowing you to use existing pipework with centres measuring anything between 136mm and 158mm.

## Product Certifications:

## Additional Information:

## Dimensions (measurements in mm)

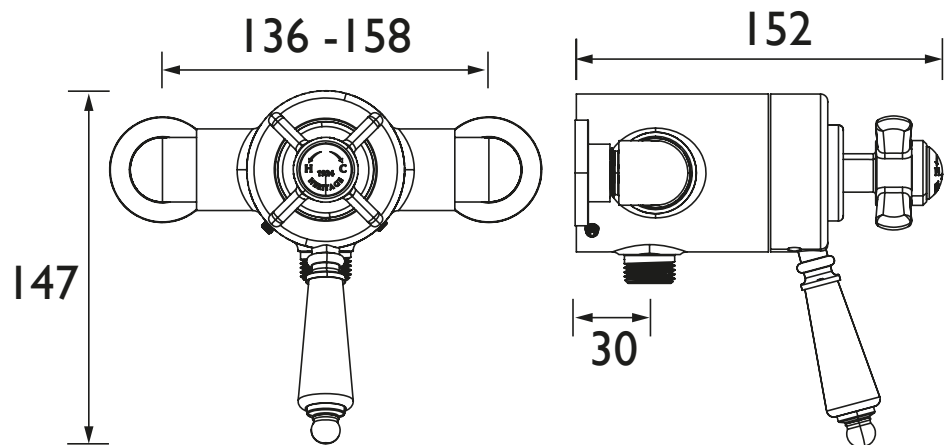

## Flow Rates (l/min)

System Pressure (bar)	0.1	0.5	1	2	3	5
With Flow Regulators (mixed)	5.8	14.9	16.8	14.5	15.5	15.4
Without Flow Regulators (mixed)	8.1	20.3	30.9	44.8	54.9	69.2